

60 or 72 cell portrait 2 rows

**60 or 72 Cell Portrait 2 Rows (Lowest Cost Layout)**

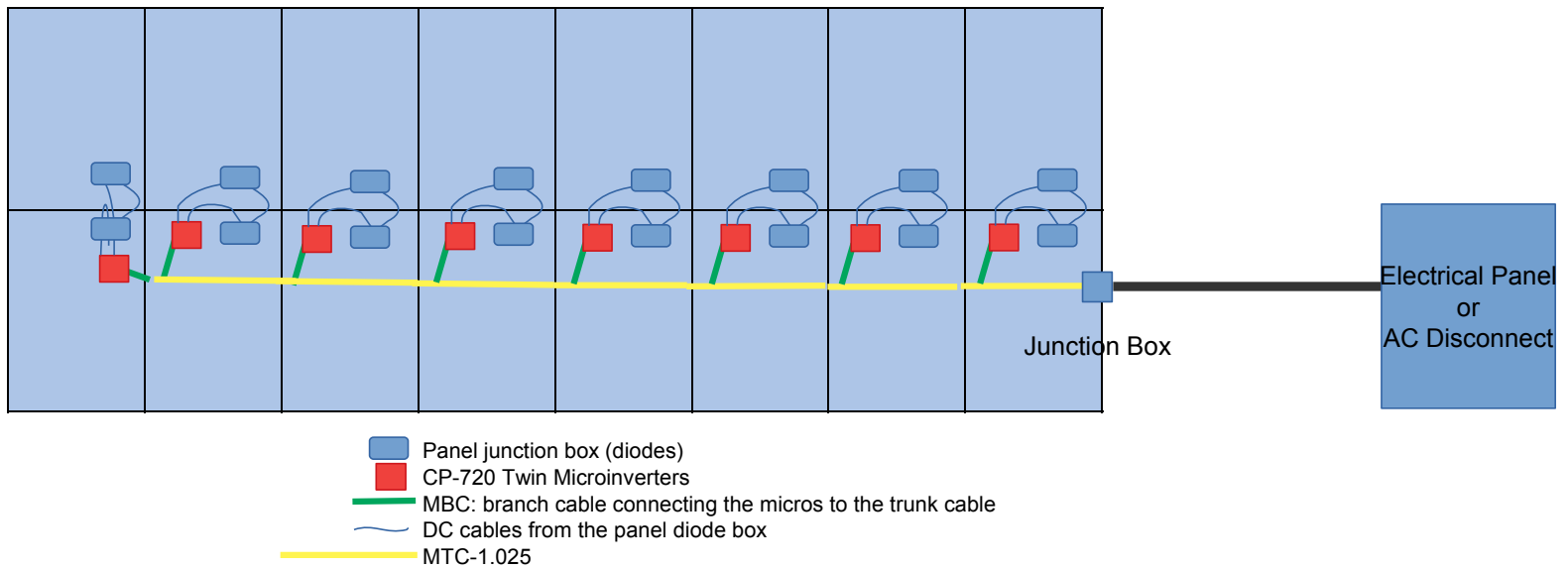

### 60 Cell Landscape 2 Rows

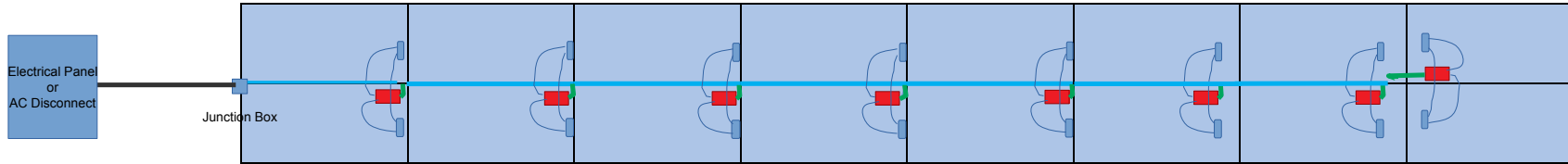

- Module junction box (diodes)
- DC cables from the module junction box
- CP-720 Twin Microinverters
- CP-250e Microinverter
- MTC-1.7: Master Trunk Cable
- MBC: branch cable connecting the micros to the trunk cable



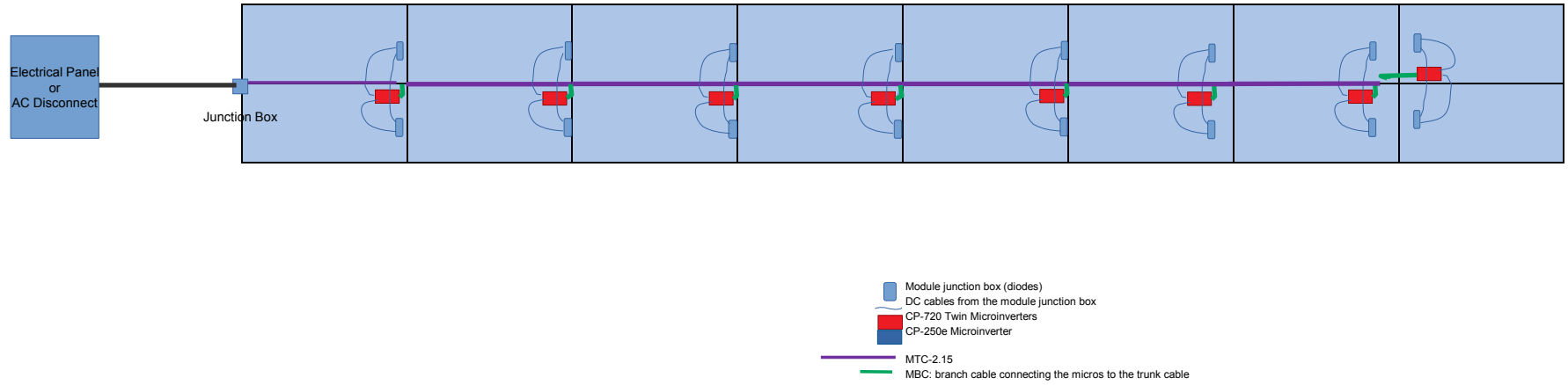



### 72 Cell Landscape 2 Rows

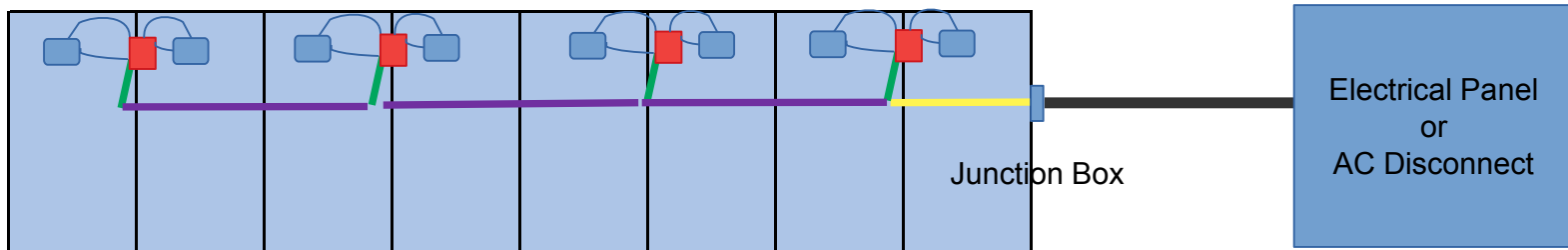

60 or 72 cell portrait 1 row

**60 or 72 Cell Portrait One Row**



-  Panel junction box (diodes)
-  CP-720 Twin Microinverters
-  MBC: branch cable connecting the micros to the trunk cable
-  DC cables from the panel diode box
-  MTC-1.025
-  MTC-2.15

### 60 Cell Landscape 1 Row (Approaching Most Expensive)

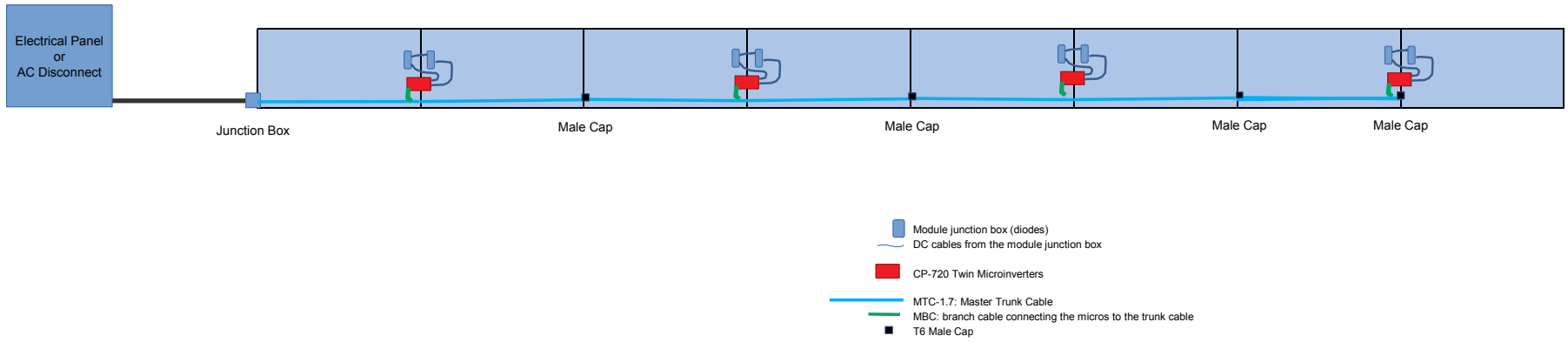

### 72 Cell Landscape 1 Row (Most Expensive)

